

90t クローラクレーン 【7090-1F】

▣ 全体図(単位 : mm)

縮尺 : 約1/150

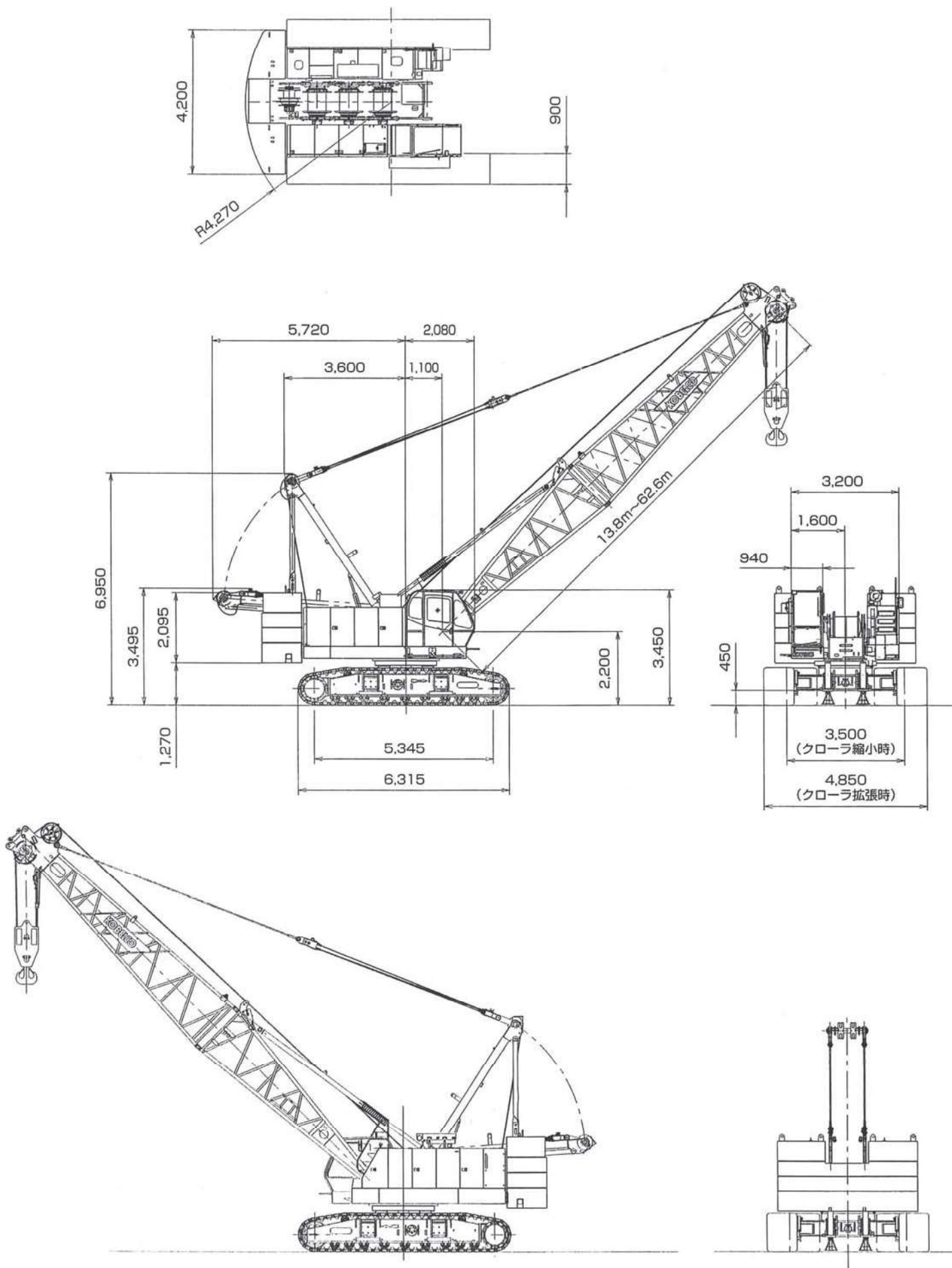

▶ ブーム構成

【7090-1F】

- →印は、ジブ使用時のガイドライン取付位置を示します。
- ※印は、これより短いブームの組立可能な構成を示します。
- 使用するガイドラインの径はφ34mmです。
- ジブ付の場合は9.1mラグ付中間ブーム（9.1A）が必要です。また、ジブなしの場合は、図中の9.1Aは9.1の使用も可能です。
- 9.1Bはタワー用ですがクレーンにも転用できます。

中間ブームの種類		
記号	ブーム長さ	備考
3.0	3.0m	ラグ無
6.1	6.1m	ラグ無
9.1	9.1m	ラグ無
9.1A	9.1m	ラグ付
9.1B	9.1m	タワー専用 (クレーンに兼用可能)

ブーム長さ m (ft.)	ブーム構成
13.8 (45)	
16.9 (55)	
19.9 (65)	※
23.0 (75)	※
26.0 (85)	※
29.1 (95)	※
32.1 (105)	※
35.2 (115)	※
38.2 (125)	※
	※

ブーム長さ m (ft.)	ブーム構成
41.2 (135)	※
	※
44.3 (145)	※
	※
47.3 (155)	※
	※
50.4 (165)	※
	※

▶ 作動範囲図

■ 主ブーム

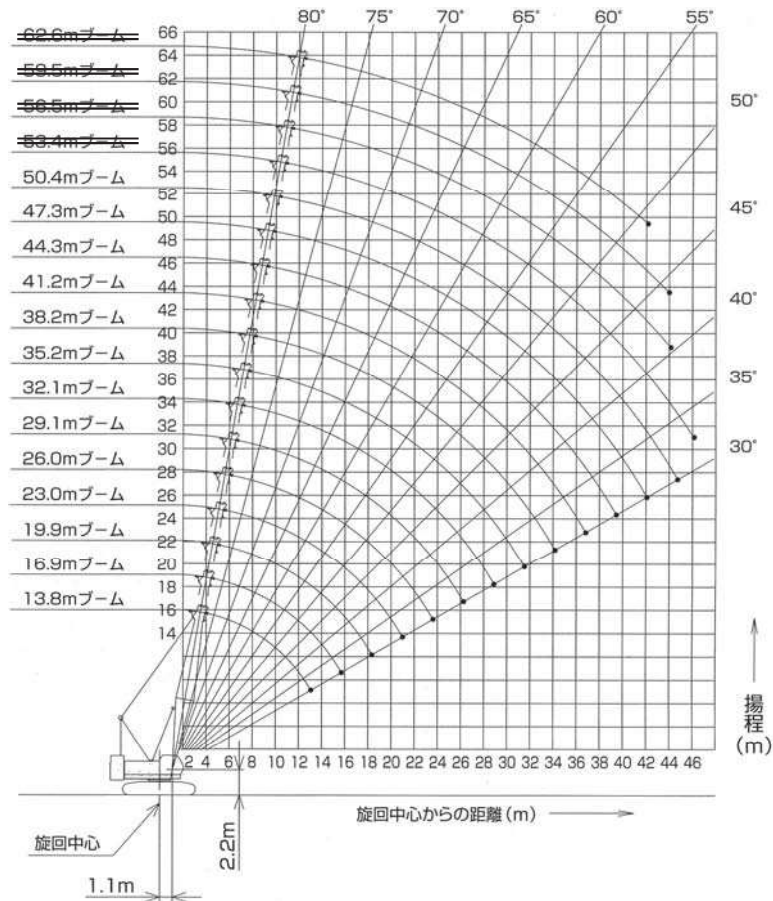

▶ 主ブーム定格総荷重表

(単位：t)

ブーム長さ 作業半径 (m)	13.8	16.9	19.9	23.0	26.0	29.1	32.1	35.2	38.2	41.2	44.3	47.3	50.4	ブーム長さ 作業半径 (m)
4.3	90.0/4.3m	87.5/4.3m	74.1/4.8m											4.3
5.0	70.9	70.8	70.7	64.9/5.4m	56.4/5.9m									5.0
6.0	55.1	55.0	55.0	54.9	54.8	50.2/6.4m								6.0
7.0	44.4	44.3	44.1	44.1	44.0	44.0	43.9	39.6/7.5m						7.0
8.0	36.6	36.5	36.3	36.2	36.1	36.1	36.0	35.9	35.7	32.5/8.5m				8.0
9.0	31.0	30.9	30.7	30.7	30.5	30.5	30.4	30.3	30.2	30.2	29.7/9.1m	27.2/9.6m		9.0
10.0	26.9	26.7	26.6	26.5	26.4	26.3	26.3	26.1	26.0	26.0	25.8	25.7	22.0/10.1m	10.0
12.0	21.1	21.0	20.8	20.7	20.6	20.5	20.4	20.3	20.2	20.1	20.0	19.8	19.8	12.0
14.0	18.7/13.2m	17.1	16.9	16.9	16.7	16.6	16.6	16.4	16.3	16.2	16.1	16.0	15.9	14.0
16.0		14.6/15.8m	14.2	14.1	14.0	13.9	13.8	13.7	13.5	13.5	13.3	13.2	13.2	16.0
18.0			12.2	12.1	11.9	11.9	11.8	11.6	11.5	11.4	11.2	11.1	11.1	18.0
20.0			11.8/18.5m	10.5	10.4	10.3	10.2	10.0	9.9	9.8	9.6	9.5	9.5	20.0
22.0				9.8/21.1m	9.1	9.0	8.9	8.7	8.6	8.5	8.4	8.2	8.2	22.0
24.0					8.2/23.8m	8.0	7.9	7.7	7.6	7.5	7.3	7.2	7.1	24.0
26.0						7.2	7.0	6.8	6.7	6.6	6.5	6.3	6.3	26.0
28.0						7.0/26.4m	6.3	6.1	6.0	5.9	5.7	5.6	5.5	28.0
30.0							6.0/29.0m	5.5	5.4	5.3	5.1	5.0	4.9	30.0
32.0								5.1/31.7m	4.8	4.8	4.6	4.4	4.4	32.0
34.0									4.4	4.3	4.1	4.0	3.9	34.0
36.0									4.3/34.3m	3.9	3.7	3.5	3.5	36.0
38.0										3.7/37.0m	3.3	3.2	3.1	38.0
40.0											3.1/39.6m	2.9	2.8	40.0
42.0												2.5	2.4	42.0
44.0												2.5/42.2m	2.1	44.0
46.0													2.0/44.9m	46.0

※表中の太線で囲まれた部分は、ブーム等の強度によって定められた値です。

【7090-1F】(ラフティングタワー)

全体図(単位：mm)

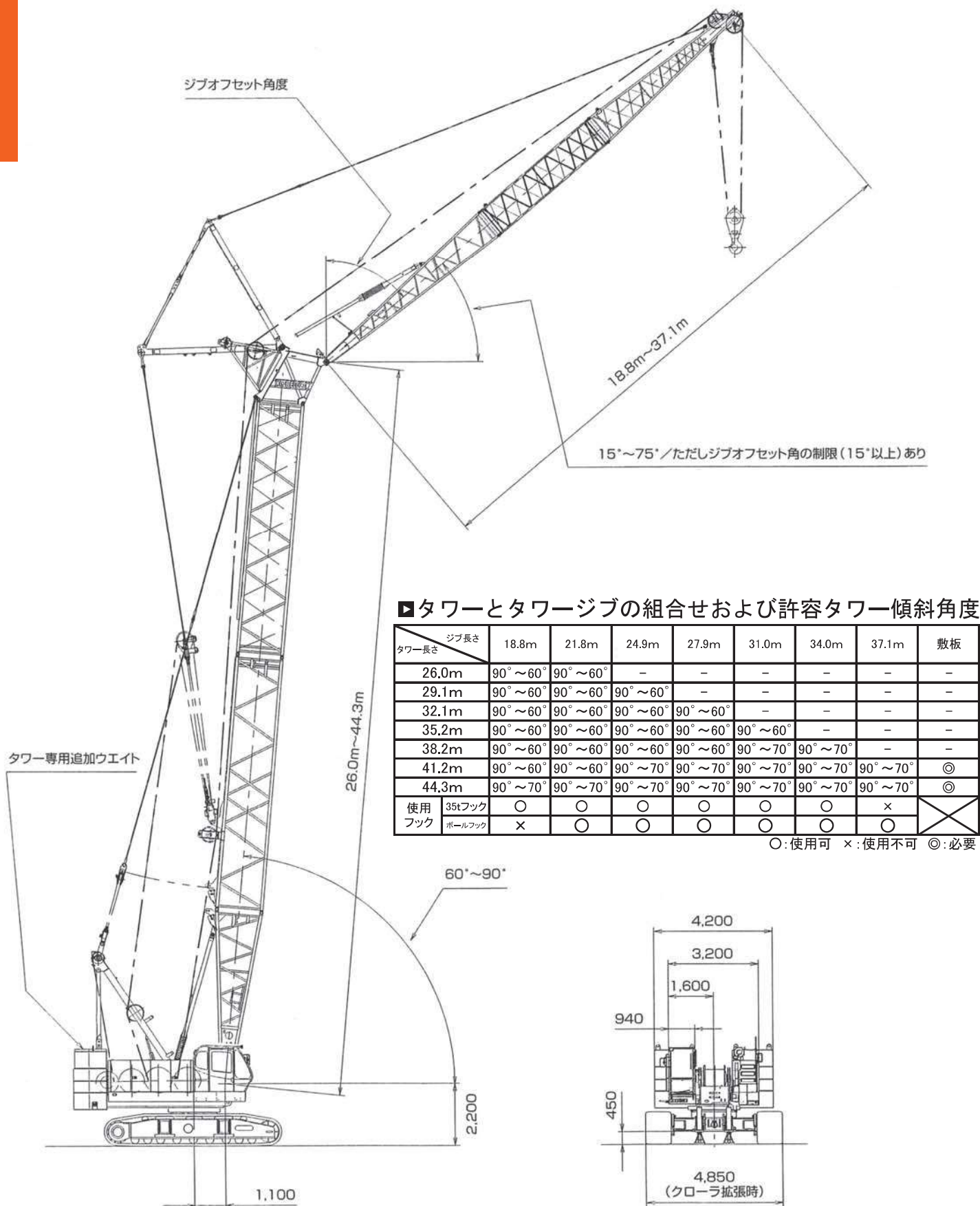

■タワーとタワージブの組合せおよび許容タワー傾斜角度

タワー長さ \ ジブ長さ	18.8m	21.8m	24.9m	27.9m	31.0m	34.0m	37.1m	敷板	
26.0m	90°~60°	90°~60°	-	-	-	-	-	-	
29.1m	90°~60°	90°~60°	90°~60°	-	-	-	-	-	
32.1m	90°~60°	90°~60°	90°~60°	90°~60°	-	-	-	-	
35.2m	90°~60°	90°~60°	90°~60°	90°~60°	90°~60°	-	-	-	
38.2m	90°~60°	90°~60°	90°~60°	90°~60°	90°~70°	90°~70°	-	-	
41.2m	90°~60°	90°~60°	90°~70°	90°~70°	90°~70°	90°~70°	90°~70°	◎	
44.3m	90°~70°	90°~70°	90°~70°	90°~70°	90°~70°	90°~70°	90°~70°	◎	
使用 フック	35tフック	○	○	○	○	○	○	×	⊗
	ボールフック	×	○	○	○	○	○	○	

○:使用可 ×:使用不可 ◎:必要

▶ タワー長さ26.0m

【7090-1F】

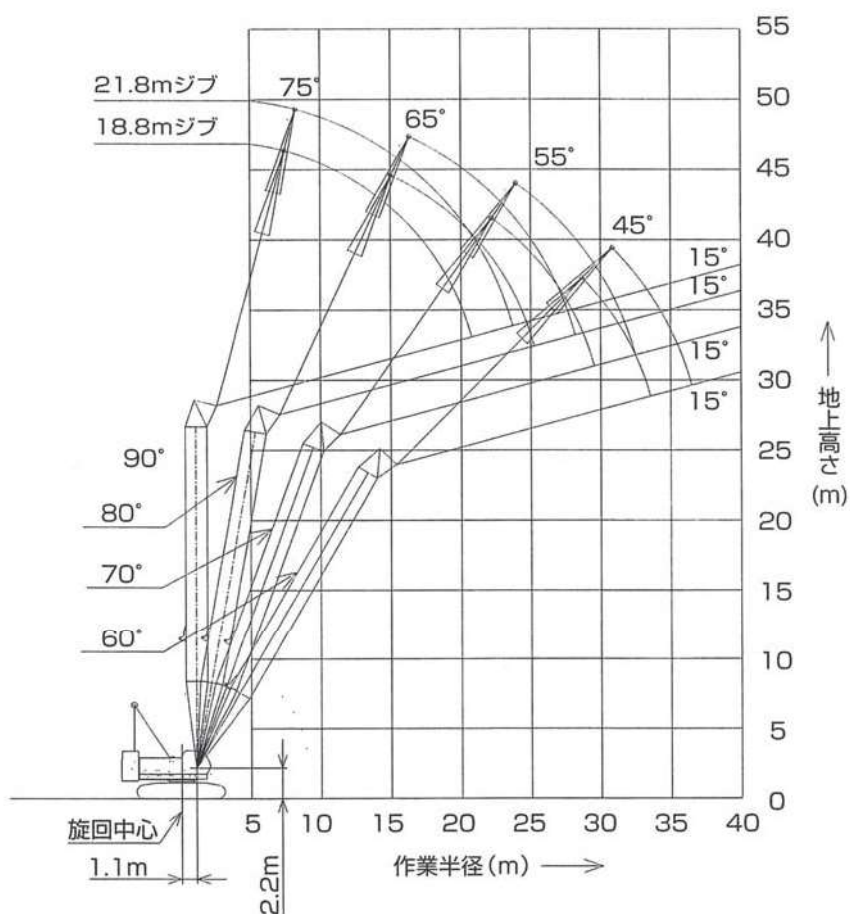

(単位:t)

タワー長さm	26.0								タワー長さm
ジブ長さm	18.8				21.8				ジブ長さm
タワー角度	90°	80°	70°	60°	90°	80°	70°	60°	タワー角度
作業半径 (m)	7.7	15.0							7.7
	8.0	15.0			15.0/8.5m				8.0
	9.0	15.0			15.0				9.0
	10.0	15.0			15.0				10.0
	12.0	15.0			15.0				12.0
	14.0	15.0	15.0/15.2m		15.0				14.0
	16.0	13.7	14.9		13.7	14.2/16.5m			16.0
	18.0	11.9	12.9		11.8	12.8			18.0
	20.0	10.6	11.4		10.4	11.2			20.0
	22.0	9.3/20.5m	10.1	8.8/22.3m	9.2	10.0			22.0
	24.0		9.1	8.0	7.8/23.4m	9.0	7.9		24.0
	26.0		8.5/24.9m	7.4		8.1	7.2		26.0
	28.0			6.7	5.6/28.7m	7.4/27.9m	6.6		28.0
	30.0			6.2/29.3m	5.4		6.1	5.0/30.8m	30.0
	32.0				5.0		5.6	4.8	32.0
34.0				4.7/33.3m		5.5/32.2m	4.5	34.0	
36.0							4.2	36.0	
38.0							4.1/36.2m	38.0	

※表中の太線で囲まれた部分は、ブーム等の強度によって定められた値です。

▶ タワー長さ29.1m

【7090-1F】

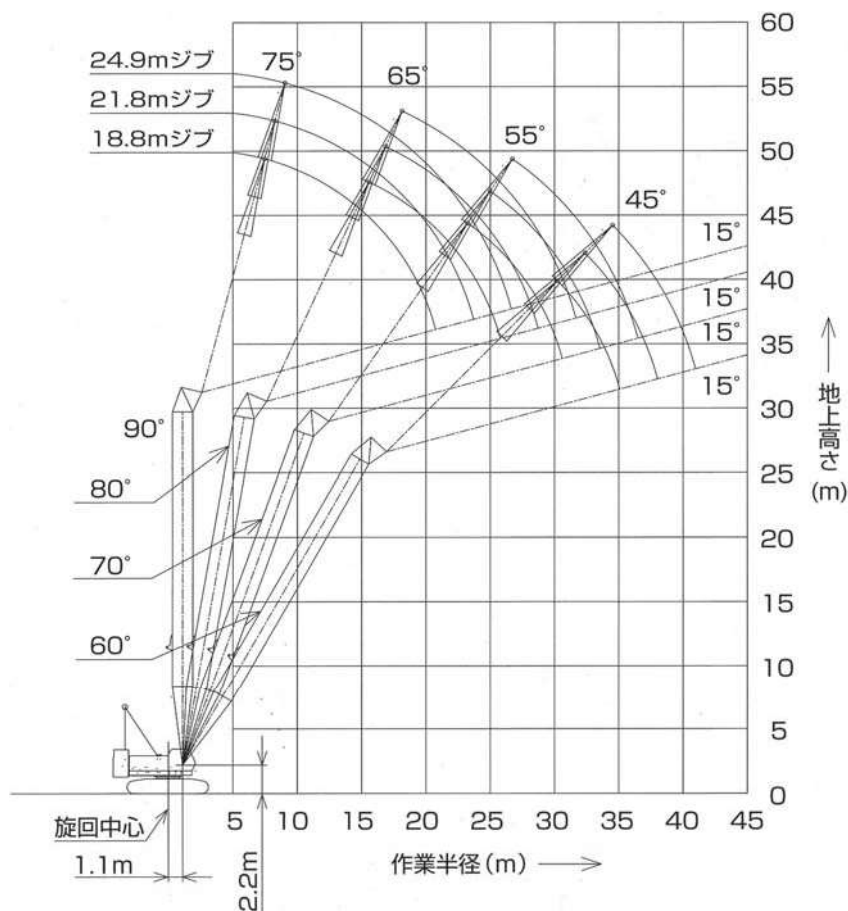

(単位：t)

タワー長さm	29.1												タワー長さm
ジブ長さm	18.8				21.8				24.9				ジブ長さm
タワー角度	90°	80°	70°	60°	90°	80°	70°	60°	90°	80°	70°	60°	タワー角度
作業半径 (m)	7.7	15.0											7.7
	8.0	15.0			15.0/8.5m								8.0
	9.0	15.0			15.0				15.0/9.3m				9.0
	10.0	15.0			15.0				15.0				10.0
	12.0	15.0			15.0				15.0				12.0
	14.0	15.0	14.9/15.7m		15.0				15.0				14.0
	16.0	13.7	14.7		13.7	13.4/17.0m			13.6				16.0
	18.0	11.9	12.7		11.8	12.6			11.8	12.1/18.3m			18.0
	20.0	10.4	11.2		10.4	11.0			10.3	10.9			20.0
	22.0	9.4/20.5m	9.9	7.9/23.3m	9.2	9.8			9.2	9.8			22.0
	24.0		8.9	7.7	8.0/23.4m	8.8	7.1/25.0m		8.3	8.8			24.0
	26.0		8.1/25.5m	7.1		8.0	6.8		7.5	8.0	6.4/26.8m		26.0
	28.0			6.4		7.3	6.3		6.9/26.3m	7.3	6.1		28.0
	30.0			5.9	4.9/30.2m	7.0/28.4m	5.8			6.7	5.7		30.0
	32.0			5.7/30.3m	4.6		5.3	4.3/32.3m		6.1/31.4m	5.3		32.0
	34.0				4.3		5.0/33.2m	4.1			4.9	3.9/34.5m	34.0
	36.0				4.1/34.8m			3.9			4.5	3.7	36.0
	38.0							3.6/37.7m			4.4/36.2m	3.5	38.0
	40.0											3.3	40.0
	42.0											3.2/40.7m	42.0

※表中の太線で囲まれた部分は、ブーム等の強度によって定められた値です。

▶ タワー長さ32.1m

【7090-1F】

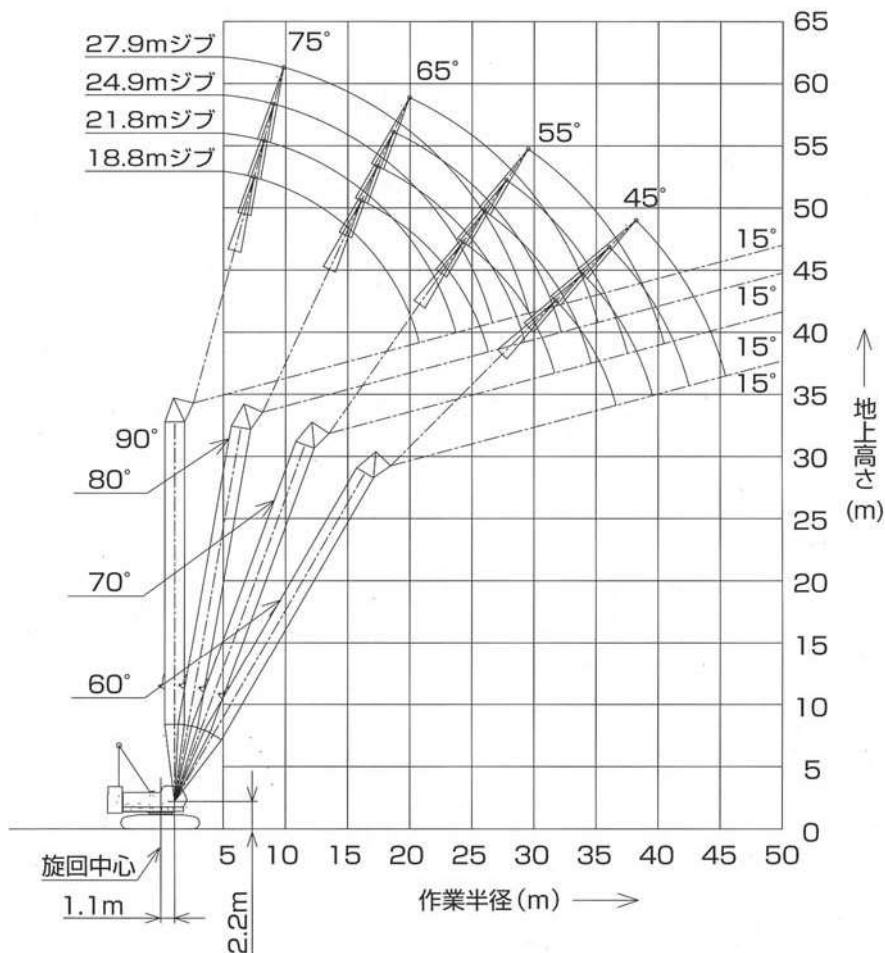

(単位：t)

タワー長さm	32.1																タワー長さm
ジブ長さm	18.8				21.8				24.9				27.9				ジブ長さm
タワー角度	90°	80°	70°	60°	90°	80°	70°	60°	90°	80°	70°	60°	90°	80°	70°	60°	タワー角度
7.7	15.0																7.7
8.0	15.0				15.0/8.5m												8.0
9.0	15.0				15.0				15.0/9.3m								9.0
10.0	15.0				15.0				15.0				15.0/10.1m				10.0
12.0	15.0				15.0				15.0				15.0				12.0
14.0	15.0				15.0				15.0				15.0				14.0
16.0	13.8	14.0/16.3m			13.7	12.6/17.6m			13.7				13.6				16.0
18.0	11.9	12.4			11.9	12.3			11.8	11.5/18.9m			11.7				18.0
20.0	10.4	10.9			10.4	10.8			10.4	10.7			10.3	10.5/20.1m			20.0
22.0	9.6/20.5m	9.7			9.2	9.6			9.2	9.6			9.1	9.4			22.0
24.0		8.7	7.1/24.3m		8.1/23.4m	8.6			8.3	8.7			8.2	8.6			24.0
26.0		7.9	6.6			7.8	6.4/26.1m		7.5	7.8	5.8/27.8m		7.4	7.7			26.0
28.0			6.1			7.1	5.9		7.0/26.3m	7.2	5.8		6.8	7.1	5.3/29.6m		28.0
30.0			5.6	4.3/31.7m		6.7/29.0m	5.5			6.6	5.4		6.0/29.3m	6.5	5.2		30.0
32.0			5.2/31.3m	4.3			5.1	3.7/33.9m		6.0/31.9m	5.0			6.0	4.9		32.0
34.0				3.9			4.7	3.7			4.6			5.5	4.5		34.0
36.0				3.6			4.6/34.3m	3.5			4.3	3.4		5.3/34.8m	4.2		36.0
38.0				3.5/36.3m				3.3			4.0/37.2m	3.2			3.9	3.0/38.2m	38.0
40.0								3.1/39.3m				3.0			3.6	2.9	40.0
42.0												2.8			3.5/40.2m	2.7	42.0
44.0												2.6/42.2m				2.5	44.0
46.0																2.2/45.1m	46.0

※表中の太線で囲まれた部分は、ブーム等の強度によって定められた値です。

▶ タワー長さ35.2m

【7090-1F】

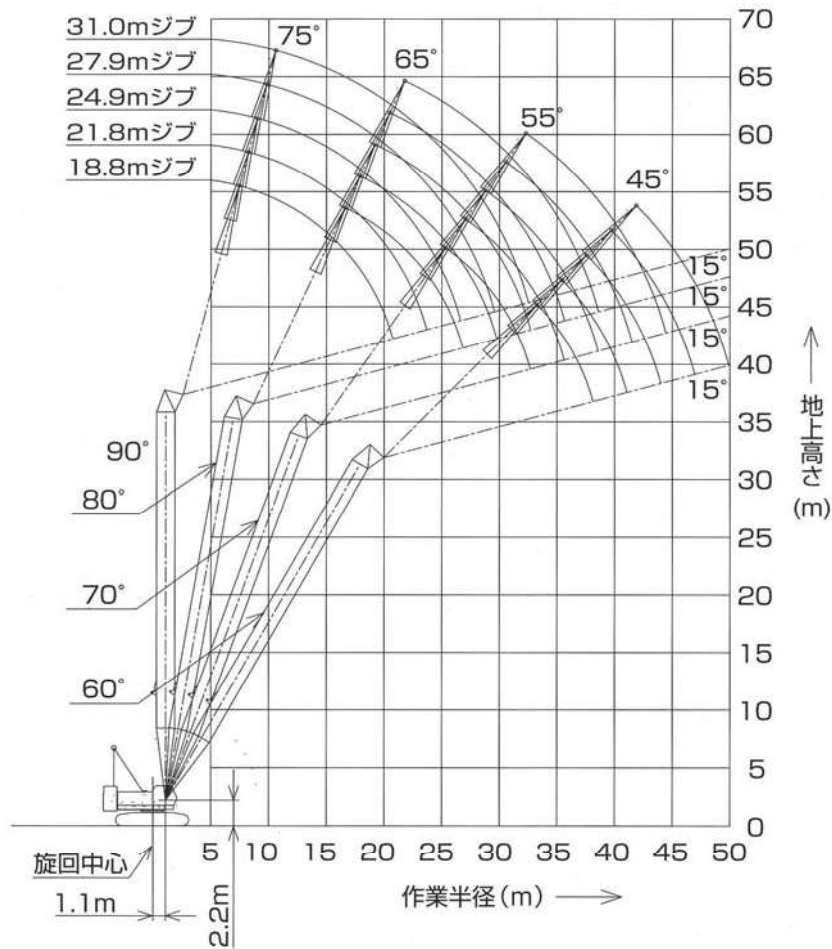

(単位：t)

タワー長さm		35.2																タワー長さm				
ジブ長さm		18.8				21.8				24.9				27.9				31.0				ジブ長さm
タワー角度		90°	80°	70°	60°	90°	80°	70°	60°	90°	80°	70°	60°	90°	80°	70°	60°	90°	80°	70°	60°	タワー角度
作業半径 (m)	7.7	15.0																			7.7	
	8.0	15.0				15.0/8.5m															8.0	
	9.0	15.0				15.0				15.0/9.3m												9.0
	10.0	15.0				15.0				15.0				15.0/10.1m				13.5/10.9m				10.0
	12.0	15.0				15.0				15.0				15.0				13.5				12.0
	14.0	15.0				15.0				15.0				15.0				13.5				14.0
	16.0	13.8	13.2/16.8m			13.7				13.7				13.6				13.5				16.0
	18.0	11.9	12.2			11.9	12.0/18.1m			11.8	10.9/19.4m			11.7				11.7				18.0
	20.0	10.4	10.7			10.4	10.6			10.4	10.5			10.3	9.9/20.7m			10.2				20.0
	22.0	9.6/20.5m	9.6			9.3	9.6			9.2	9.5			9.2	9.2			9.1	9.1			22.0
	24.0		8.6	6.5/25.4m		8.2/23.4m	8.6			8.3	8.5			8.2	8.4			8.2	8.2			24.0
	26.0		7.8	6.3		7.8	5.8/27.1m			7.5	7.7			7.4	7.6			7.4	7.5			26.0
	28.0		7.4/26.5m	5.9		7.1	5.6			7.0/26.3m	7.0	5.3/28.9m		6.8	6.9			6.7	6.9			28.0
	30.0			5.4		6.4/29.5m	5.3			6.4	5.1			6.0/29.3m	6.3	4.8/30.6m		6.2	6.3			30.0
	32.0			4.9	3.6/33.2m		4.8			5.9	4.8			5.8	4.5			5.7	5.8	4.3/32.4m		32.0
	34.0			4.8/32.4m	3.6		4.5	3.2/35.4m		5.7/32.4m	4.4			5.4	4.3			5.3/32.2m	5.3	4.1		34.0
	36.0				3.4		4.2/35.3m	3.2			4.1	2.9/37.5m		5.0/35.4m	4.0			5.0	3.9			36.0
	38.0				3.1/37.8m			3.0			3.8	2.9			3.7	2.5/39.7m		4.6	3.6			38.0
	40.0							2.8			3.7/38.3m	2.7			3.4	2.5		4.5/38.3m	3.4	2.1/41.9m		40.0
	42.0							2.6/40.8m				2.5			3.2/41.2m	2.3			3.1	2.1		42.0
44.0											2.3/43.7m				2.1			2.9	1.9		44.0	
46.0															1.9			2.9/44.2m	1.8		46.0	
48.0															1.8/46.7m				1.7		48.0	

※表中の太線で囲まれた部分は、ブーム等の強度によって定められた値です。

▶ タワー長さ38.2m

【7090-1F】

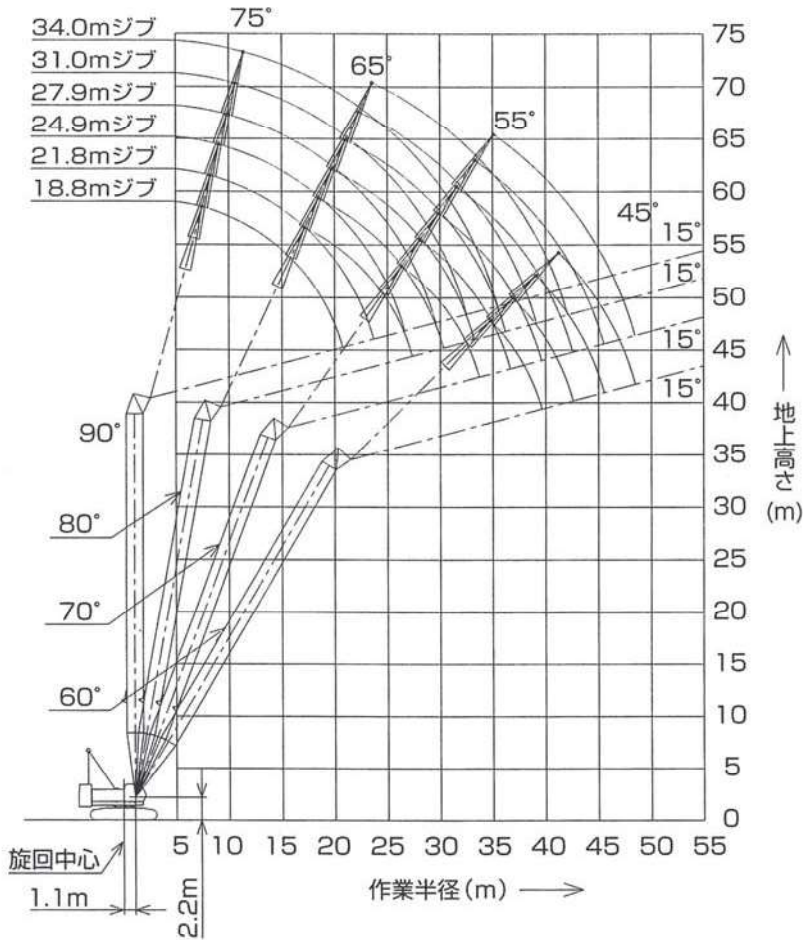

(単位:t)

タワー長さm	38.2				タワー長さm
ジブ長さm	18.8				ジブ長さm
タワー角度	90°	80°	70°	60°	タワー角度
7.7	15.0				7.7
8.0	15.0				8.0
9.0	15.0				9.0
10.0	15.0				10.0
12.0	15.0				12.0
14.0	15.0				14.0
16.0	13.8	12.5/17.3m			16.0
18.0	11.9	12.0			18.0
20.0	10.5	10.5			20.0
22.0	9.7/20.5m	9.3			22.0
24.0		8.4			24.0
26.0		7.6	5.8/26.4m		26.0
28.0		7.1/27.1m	5.4		28.0
30.0			5.1		30.0
32.0			4.7		32.0
34.0			4.3/33.4m	3.0/34.8m	34.0
36.0				2.9	36.0
38.0				2.7	38.0
40.0				2.4/39.4m	40.0
42.0					42.0
44.0					44.0
46.0					46.0
48.0					48.0
50.0					50.0

(単位:t)

タワー長さm	38.2															タワー長さm						
ジブ長さm	21.8				24.9				27.9				31.0			34.0				ジブ長さm		
タワー角度	90°	80°	70°	60°	90°	80°	70°	60°	90°	80°	70°	60°	90°	80°	70°	90°	80°	70°	タワー角度			
7.7																			7.7			
8.0	15.0/8.5m																		8.0			
9.0	15.0				15.0/9.3m											13.5/10.9m		11.5/11.7m	9.0			
10.0	15.0				15.0								15.0/10.1m						10.0			
12.0	15.0				15.0								15.0			13.5		11.5	12.0			
14.0	15.0				15.0								15.0			13.5		11.5	14.0			
16.0	13.8				13.7								13.6			13.5		11.5	16.0			
18.0	11.9	11.3/18.6m			11.8	10.3/19.9m							11.8			11.7		11.5	18.0			
20.0	10.4	10.4			10.4	10.3							10.3	9.4/21.2m		10.3		10.2	20.0			
22.0	9.3	9.3			9.2	9.2							9.2	9.0		9.1	8.6/22.5m	9.1	7.9/23.8m	22.0		
24.0	8.2/23.4m	8.4			8.3	8.3							8.2	8.2		8.2	8.0	8.1	7.9	24.0		
26.0		7.6			7.5	7.5							7.4	7.4		7.4	7.3	7.3	7.2	26.0		
28.0		6.9	5.2/28.2m		7.1/26.3m	6.9	4.8/29.9m						6.8	6.8		6.7	6.7	6.7	6.6	28.0		
30.0		6.3	4.8		6.3	4.8							6.1/29.3m	6.2	4.4/31.7m	6.2	6.1	6.1	6.0	30.0		
32.0			4.6			5.8	4.4						5.7	4.3		5.7	5.6	4.0/33.4m	5.6	5.6	32.0	
34.0			4.2			5.5/33.0m	4.1						5.3	4.0		5.6/32.2m	5.2	3.9	5.2	5.1	3.6/35.2m	34.0
36.0			3.9	2.5/36.9m			3.8						4.9/35.9m	3.7			4.8	3.6	4.6/35.2m	4.8	3.5	36.0
38.0			3.8/36.4m	2.5			3.5	2.2/39.1m					3.4				4.5	3.4		4.4	3.3	38.0
40.0				2.3			3.3/39.3m	2.2					3.2	1.8/41.2m		4.3/38.8m	3.1		4.1	3.0	40.0	
42.0				2.1				2.0					3.0	1.8				2.9		3.8/41.8m	2.8	42.0
44.0				1.9/42.3m				1.8					2.9/42.3m	1.5				2.7			2.6	44.0
46.0								1.5/45.2m										2.5/45.2m			2.5	46.0
48.0																				2.3	48.0	
50.0																				2.2/48.2m	50.0	

※表中の太線で囲まれた部分は、ブーム等の強度によって定められた値です。

▶ タワー長さ41.2m

【7090-1F】

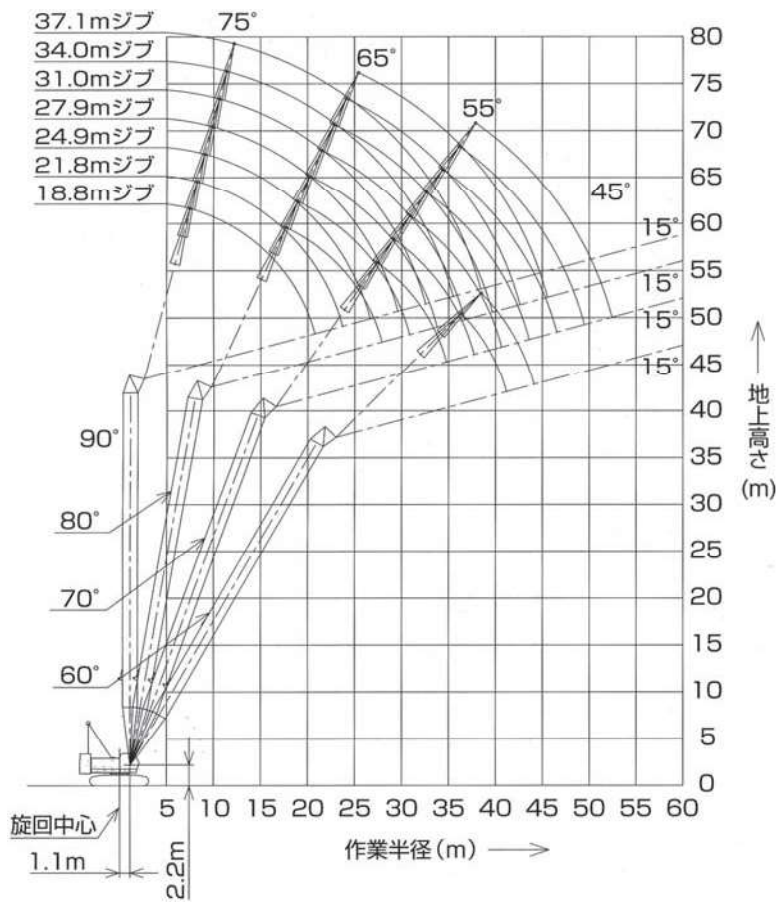

(単位：t)

タワー長さm	41.2				タワー長さm
ジブ長さm	18.8				ジブ長さm
タワー角度	90°	80°	70°	60°	タワー角度
7.7	15.0				7.7
8.0	15.0				8.0
9.0	15.0				9.0
10.0	15.0				10.0
12.0	15.0				12.0
14.0	15.0				14.0
16.0	13.8	11.8/17.9m			16.0
18.0	11.9	11.7			18.0
20.0	10.5	10.3			20.0
22.0	9.8/20.5m	9.1			22.0
24.0		8.2			24.0
26.0		7.4	5.4/27.5m		26.0
28.0		6.7/27.6m	5.2		28.0
30.0			4.8		30.0
32.0			4.4		32.0
34.0			4.1		34.0
36.0			3.9/34.5m	2.4/36.3m	36.0
38.0				2.3	38.0
40.0				2.1	40.0
42.0				1.9/40.9m	42.0
44.0					44.0
46.0					46.0
48.0					48.0
50.0					50.0

(単位：t)

タワー長さm	41.2																		タワー長さm		
ジブ長さm	21.8			24.9			27.9			31.0			34.0			37.1			ジブ長さm		
タワー角度	90°	80°	70°	90°	80°	70°	90°	80°	70°	90°	80°	70°	90°	80°	70°	90°	80°	70°	タワー角度		
7.7																				7.7	
8.0	15.0/8.5m																			8.0	
9.0	15.0			15.0/9.3m																9.0	
10.0	15.0			15.0			15.0/10.1m			13.5/10.9m			11.5/11.7m							10.0	
12.0	15.0			15.0			15.0			13.5			11.5			9.5/12.5m				12.0	
14.0	15.0			15.0			15.0			13.5			11.5			9.5				14.0	
16.0	13.8			13.7			13.6			13.5			11.5			9.5				16.0	
18.0	11.9	10.7/19.2m		11.8			11.8			11.7			11.5			9.4				18.0	
20.0	10.4	10.2		10.4	9.7/20.4m		10.3	8.9/21.7m		10.3			10.2			9.1				20.0	
22.0	9.3	9.1		9.2	8.9		9.2	8.8		9.1	8.2/23.0m		9.1			8.7				22.0	
24.0	8.3/23.4m	8.2		8.3	8.1		8.2	8.0		8.2	7.8		8.1	7.5/24.3m		8.2	7.1/25.9m			24.0	
26.0		7.4		7.5	7.4		7.4	7.3		7.4	7.2		7.3	6.9		7.4	7.0			26.0	
28.0		6.8	4.9/29.2m		7.1/26.3m	6.7		6.8	6.6		6.7	6.5		6.7	6.4		6.7	6.3		28.0	
30.0		6.2	4.7			6.2	4.4/31.0m	6.1/29.3m		6.1			6.2	6.0		6.1	5.9			30.0	
32.0		6.0/30.5m	4.3			5.7	4.2		5.6	4.0/32.7m	5.7	5.5		5.6	5.4		5.7	5.3		32.0	
34.0			4.0			5.2/33.5m	3.9		5.1	3.8	5.6/32.2m	5.1	3.6/34.5m	5.2	5.0		5.2	4.9		34.0	
36.0			3.7				3.6		4.8	3.5		4.7	3.4	4.6/35.2m	4.6	3.3/36.2m	4.9	4.5		36.0	
38.0			3.4/37.4m	2.0/38.4m			3.3		4.6/36.4m	3.2		4.4	3.1		4.3	3.0	4.5	4.2	2.9/38.4m	38.0	
40.0				1.9			3.1			3.0		4.1/39.4m	2.9		4.0	2.8	4.4/38.1m	3.9	2.7	40.0	
42.0					1.7			3.0/40.4m			2.8			2.7		3.7	2.6		3.7	2.4	42.0
44.0						1.6/43.8m					2.5/43.3m			2.5		3.7/42.9m	2.4		3.4	2.2	44.0
46.0														2.3			2.2		3.2/45.3m	2.1	46.0
48.0															2.2/46.2m		2.0		1.9	48.0	
50.0																	1.9/49.2m		1.7	50.0	
52.0																			1.6	52.0	

※表中の太線で囲まれた部分は、ブーム等の強度によって定められた値です。

▶ タワー長さ44.3m

【7090-1F】

(単位:t)

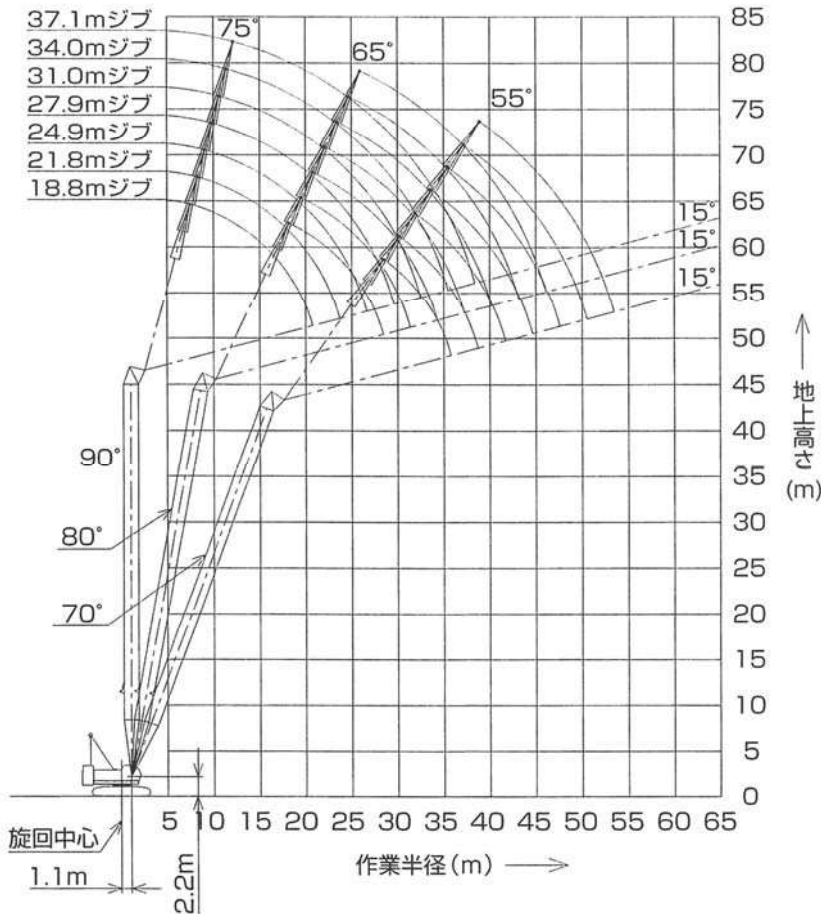

タワー長さm	44.3			タワー長さm
ジブ長さm	18.8			ジブ長さm
タワー角度	90°	80°	70°	タワー角度
7.7	15.0			7.7
8.0	15.0			8.0
9.0	15.0			9.0
10.0	15.0			10.0
12.0	15.0			12.0
14.0	15.0			14.0
16.0	13.8			16.0
18.0	11.9	11.1/18.4m		18.0
20.0	10.5	10.1		20.0
22.0	9.8/20.5m	9.1		22.0
24.0		8.1		24.0
26.0		7.4		26.0
28.0		6.7	4.8/28.5m	28.0
30.0		6.6/28.1m	4.5	30.0
32.0			4.2	32.0
34.0			3.8	34.0
36.0			3.5/35.5m	36.0
38.0				38.0
40.0				40.0
42.0				42.0
44.0				44.0
46.0				46.0
48.0				48.0
50.0				50.0

(単位:t)

タワー長さm	44.3															タワー長さm			
ジブ長さm	21.8			24.9			27.9			31.0			34			37.1			ジブ長さm
タワー角度	90°	80°	70°	90°	80°	70°	90°	80°	70°	90°	80°	70°	90°	80°	70°	90°	80°	70°	タワー角度
7.7																			7.7
8.0	15.0/8.5m																		8.0
9.0	15.0			15.0/9.3m															9.0
10.0	15.0			15.0			15.0/10.1m			13.5/10.9m			11.5/11.7m						10.0
12.0	15.0			15.0			15.0			13.5			11.5			9.5/12.5m			12.0
14.0	15.0			15.0			15.0			13.5			11.5			9.5			14.0
16.0	13.8			13.7			13.6			13.5			11.5			9.5			16.0
18.0	11.9	10.1/19.7m		11.9			11.8			11.7			11.5			9.4			18.0
20.0	10.4	9.9		10.4	9.2/21.0m		10.3			10.3			10.2			9.0			20.0
22.0	9.3	8.9		9.2	8.7		9.2	8.4/22.3m		9.1	7.8/23.5m		9.1			8.7			22.0
24.0	8.3/23.4m	8.0		8.3	7.9		8.2	7.7		8.2	7.6		8.1	7.1/24.8m		8.2			24.0
26.0		7.3		7.5	7.2		7.5	7.1		7.4	7.0		7.3	6.7		7.4	6.7/26.5m		26.0
28.0		6.6		7.1/26.3m	6.6		6.8	6.4		6.7	6.4		6.7	6.3		6.7	6.2		28.0
30.0		6.1	4.3/30.3m		6.0		6.1/29.3m	5.9		6.2	5.8		6.1	5.7		6.2	5.6		30.0
32.0		5.7/31.1m	4.0		5.5	3.9		5.4	3.5/33.8m	5.7	5.4		5.6	5.3		5.7	5.2		32.0
34.0			3.7		5.1	3.6		5.0	3.5	5.6/32.2m	5.0	3.2/35.5m	5.2	4.9		5.3	4.8		34.0
36.0			3.4		3.4		3.4	3.2		4.6	3.1	4.7/35.2m	4.5	2.8/37.3m	4.9	4.4			36.0
38.0			3.2		3.1		4.4/37.0m	3.0		4.3	2.9		4.2	2.7	4.5	4.1	2.4/39.4m		38.0
40.0			3.1/38.5m			2.9		2.8		4.0/39.9m	2.7		3.9	2.5	4.4/38.1m	3.8	2.3		40.0
42.0						2.5/41.4m		2.6			2.4			3.6	2.3		3.6	2.1	42.0
44.0								2.3			2.2			3.5/42.8m	2.1		3.3	2.0	44.0
46.0									2.1/44.3m		2.1				2.0		3.1/45.8m	1.8	46.0
48.0											1.8/47.3m				1.8			1.6	48.0
50.0															1.6				50.0

※表中の太線で囲まれた部分は、ブーム等の強度によって定められた値です。